

MCTS II

Multi Channel Current Transducer System

Specifications



Electronics-Rack

- Modular system for up to six transducer power supply channels
- Galvanic separation between channels
- Standard transducer status readout interface
- Supply voltage for active burden modules
- 19"-rack mountable device



MCTS II Front



MCTS II Rear

General Data	
Operation Temperature:	-10 ... 60 °C
Operation Humidity:	20 ... 90 % RH, noncondensing
Warranty period:	36 Months

Electrical Data	
Supply voltage:	100-240 VAC, 50/60 Hz, fused with 6 A slow blow
Output voltages:	+ 15 V _{DC} , 3.4 A _{max} / -15 V _{DC} , 2.0 A _{max}
Max. Power Consumption:	The maximum power consumption depends on the number of channels installed, the number of transducers connected and the current consumption of each transducer. The maximum power consumption of a six channel MCTS with transducers IN 2000-S at 2000 A _{rms} primary current is around 175 W.

Power and Transducer Status Functions

Channel and transducer status are visible at the MCTS front panel and can be read out via the Status-Readout Interface

Power 1
●

Status ●

Power LED **green**: Channel installed

Power LED off: Channel not installed

Status LED **green**: Transducer ok

Status LED **red**: Transducer overload or open output

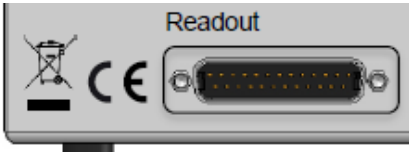

This interface gives out the transducer status by means of potential free relay contacts.

Switching voltage: 200 V

Switching current: 2 A

A status readout cable is available as an option.

Status-Readout-Interface

DC-voltage output for active burden modules

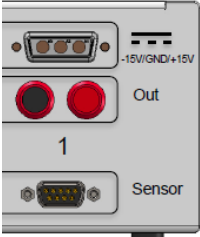

Normally the current transducers for higher primary current levels are not able to drive much more than 1 V at the output. If this is enough, our passive plug-on burden resistors are the right solution to get a mV/A-signal out of the sensor. If the connected measurement instrument demands a higher voltage signal level, our active plug-on voltage modules are the right solution. These deliver 7 V_{rms} (± 9.9 V_{pk}) at transducer nominal primary current.

Current Transducers

Type	CT 100	CT 200	CT 400	CT 500	CT 1000	CT 2000
Current Range	100 A	200 A	400 A	500 A	1000 A	2000 A
DC / AC _{rms} (Crestfactor 2)						
100 ms Overload	20 kA _{pk}	20 kA _{pk}	20 kA _{pk}	3 kA _{pk}	5 kA _{pk}	10 kA _{pk}
Ratio	500 : 1	1000 : 1	1500 : 1	750 : 1	1500 : 1	2000 : 1
Output Range	0 ... 200 mA _{rms}	0 ... 200 mA _{rms}	0 ... 266.667 mA _{rms}	0 ... 666.667 mA _{rms}	0 ... 666.667 mA _{rms}	0 ... 1 A _{rms}
Max. Measuring Resistance ¹	25 Ω	20 Ω	10 Ω	5 Ω	4 Ω	3.5 Ω
Bandwidth (-3 dB)	DC ... 2 MHz	DC ... 1.1 MHz	DC ... 800 kHz	DC ... 520 kHz	DC ... 440 kHz	DC ... 140 kHz
Step Response (0 ... 90 %)	0.2 μs	0.2 μs	1 μs	1 μs	1 μs	1 μs
DC Accuracy (of MR) ²	0.002 %	0.001 %	0.0008 %	0.00115 %	0.0012 %	0.0012 %
AC Accuracy (of MV) ³						
> 0 ... ≤ 100 Hz	0.015 %	0.015 %	0.015 %	0.015 %	0.015 %	0.015 %
> 100 ... ≤ 1000 Hz	0.025 %	0.02 %	0.02 %	0.02 %	0.02 %	0.05 %
> 1000 ... ≤ 10000 Hz	0.2 %	0.15 %	0.15 %	0.1 %	0.15 %	0.25 %
> 10000 ... ≤ 50000 Hz ⁴	0.5 %	0.5 %	0.5 %	0.2 %	1.5 %	1 % ⁴
> 50000 ... ≤ 100000 Hz	1 %	1 %	1 %	0.5 %	4 %	
Angular Accuracy						
> 0 ... ≤ 100 Hz	0.01 °	0.01 °	0.01 °	0.01 °	0.01 °	0.01 °
> 100 ... ≤ 1000 Hz	0.05 °	0.02 °	0.01 °	0.01 °	0.01 °	0.05 °
> 1000 ... ≤ 10000 Hz	0.1 °	0.05 °	0.1 °	0.05 °	0.1 °	0.1 °
> 10000 ... ≤ 50000 Hz ⁴	0.25 °	0.25 °	0.5 °	0.5 °	1 °	1 ° ⁴
> 50000 ... ≤ 100000 Hz	0.5 °	0.5 °	1 °	1 °	2 °	
Temp.-Coefficient (of MR)	0.2 ppm/K	0.2 ppm/K	0.1 ppm/K	1 ppm/K	0.3 ppm/K	0.1 ppm/K
Temperature Range	-40 ... 85 °C	-40 ... 85 °C	-40 ... 85 °C	-40 ... 85 °C	-40 ... 85 °C	-40 ... 85 °C
Test Voltage 50 Hz	4.95 kV	4.95 kV	4.95 kV	4.2 kV	4.2 kV	6 kV
Inner Diameter	28 mm	28 mm	28 mm	38 mm	38 mm	70 mm
Mass	0.275 kg	0.295 kg	0.305 kg	1.3 kg	1.3 kg	4.2 kg

¹ At full scale and 25 °C. For other current values and temperatures see graphs below. Max measuring resistance = cable loop resistance + burden resistance (see page 5).

² Error of measuring range. At 25 °C.

³ Error of measured value. For range 3 % ... 100 %. Test current 0 ... 100 Arms, DC ... 100 kHz. At 25 °C.

⁴ CT 2000: 10000 ... ≤ 20000 Hz. The precision frequency range of CT 2000 is limited to 20 kHz.

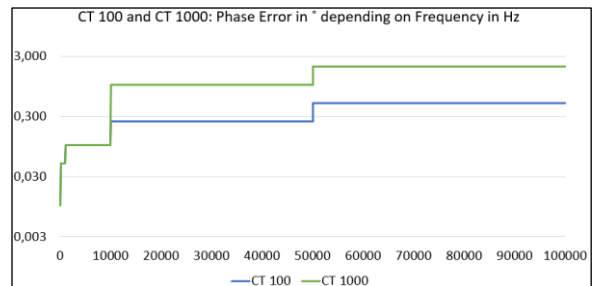
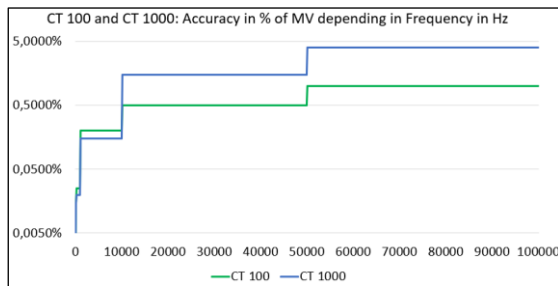

Maximum measuring resistance (cable- + burden-resistance) depending on primary rms current and surrounding temperature

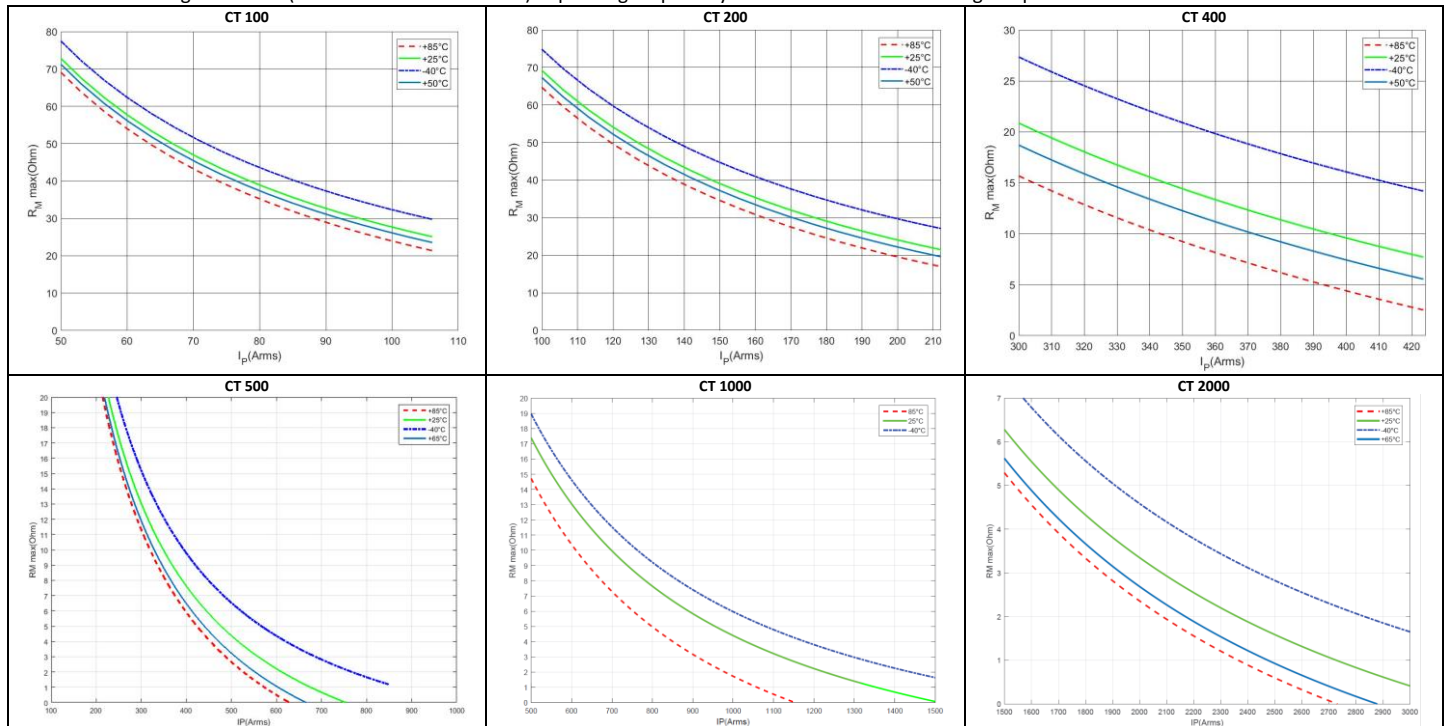

Burden Modules



The transducer system delivers the transducer output current at the 4 mm output terminals on the back panel of the rack. For those instruments that don't have current input terminals, optional high precision passive and active plug-on burden modules with very low phase angle error are available. The active voltage output modules are supplied by the MCTS rack with a 3-pole D-SUB connector.

Passive plug-on burden resistors



Passive plug-on burden resistors are available from 1 Ω to 50 Ω. The burden resistor is limited by the transducer and the length of the connection cable. For higher output voltages active plug-on burden amplifiers are available.

Order Number	Resistance Value	Accuracy	Frequency Influence	Phase Error	Bandwidth	Max. Output Voltage	Load Influence
MCTS/BR1/0.025	1 Ω	0.025 % of MV	0.0005 %/kHz	< 1° @ 100 kHz	> 1 MHz	1.00 V _{rms} @ 1000 mA _{rms}	< 0.1 ppm/mW
MCTS/BR1.5/0.025	1.5 Ω	0.025 % of MV	0.0005 %/kHz	< 1° @ 100 kHz	> 1 MHz	1.00 V _{rms} @ 667 mA _{rms}	< 0.1 ppm/mW
MCTS/BR2.5/0.025	2.5 Ω	0.025 % of MV	0.0005 %/kHz	< 1° @ 100 kHz	> 1 MHz	1.58 V _{rms} @ 632 mA _{rms}	< 0.1 ppm/mW
MCTS/BR3.75/0.025	3.75 Ω	0.025 % of MV	0.0005 %/kHz	< 1° @ 100 kHz	> 1 MHz	1.94 V _{rms} @ 516 mA _{rms}	< 0.1 ppm/mW
MCTS/BR5/0.025	5 Ω	0.025 % of MV	0.0005 %/kHz	< 1° @ 100 kHz	> 1 MHz	2.24 V _{rms} @ 447 mA _{rms}	< 0.1 ppm/mW
MCTS/BR10/0.015	10 Ω	0.015 % of MV	0.0005 %/kHz	< 1° @ 100 kHz	> 1 MHz	3.16 V _{rms} @ 316 mA _{rms}	< 0.1 ppm/mW
MCTS/BR25/0.015	25 Ω	0.015 % of MV	0.0005 %/kHz	< 1° @ 100 kHz	> 1 MHz	5.00 V _{rms} @ 200 mA _{rms}	< 0.1 ppm/mW
MCTS/BR50/0.015	50 Ω	0.015 % of MV	0.0005 %/kHz	< 1° @ 100 kHz	> 1 MHz	7.07 V _{rms} @ 141 mA _{rms}	< 0.1 ppm/mW

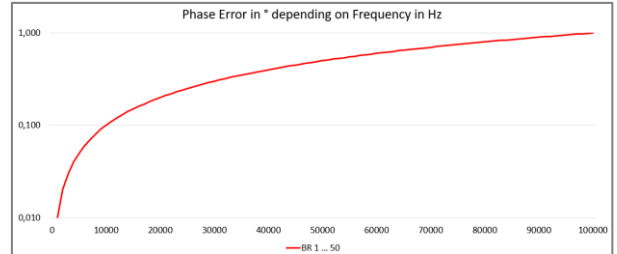
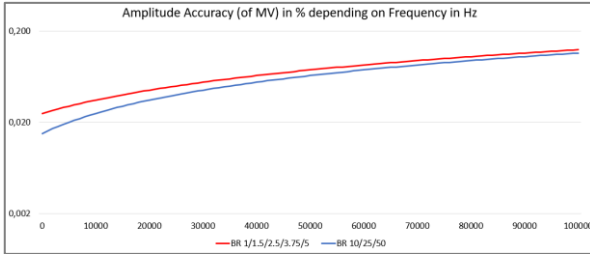

Transducer	Passive BR	Scaling	Output Voltage
CT 100	MCTS/BR10/0.015	20 mV/A	2 V _{rms} @ 100 A _{rms}
CT 200	MCTS/BR10/0.015	10 mV/A	2 V _{rms} @ 200 A _{rms}
CT 400	MCTS/BR3.75/0.025	2.5 mV/A	1 V _{rms} @ 400 A _{rms}
CT 500	MCTS/BR1.5/0.025	2 mV/A	1 V _{rms} @ 500 A _{rms}
CT 1000	MCTS/BR1.5/0.025	1 mV/A	1 V _{rms} @ 1000 A _{rms}
CT 2000	MCTS/BR1/0.025	0.5 mV/A	1 V _{rms} @ 2000 A _{rms}

Active plug-on voltage output modules



The output voltage level the transducer can drive is limited. The active plug-on burden modules combine a very precise burden resistor with a highly accurate voltage amplifier. The plug-on burden voltage modules deliver 7 V_{rms} (± 9.9 V_{pk}) at transducer nominal value.

Order Number	Input Resistance	Accuracy	Frequency Influence	Phase Error	Bandwidth	Max. Output Voltage	Load Influence
MCTS/VM1/0.02	1 Ω	0.01 % of MV + 0.01 % of MR	0.015 %/kHz	< 1° @ 100 kHz	> 300 kHz	7 V _{rms} @ 1000 mA _{rms}	< 0.1 ppm/mW
MCTS/VM0.66/0.02	1.5 Ω	0.01 % of MV + 0.01 % of MR	0.015 %/kHz	< 1° @ 100 kHz	> 300 kHz	7 V _{rms} @ 667 mA _{rms}	< 0.1 ppm/mW
MCTS/VM0.4/0.02	2.5 Ω	0.01 % of MV + 0.01 % of MR	0.015 %/kHz	< 1° @ 100 kHz	> 300 kHz	7 V _{rms} @ 400 mA _{rms}	< 0.1 ppm/mW
MCTS/VM0.26/0.02	3.75 Ω	0.01 % of MV + 0.01 % of MR	0.015 %/kHz	< 1° @ 100 kHz	> 300 kHz	7 V _{rms} @ 267 mA _{rms}	< 0.1 ppm/mW
MCTS/VM0.2/0.02	5 Ω	0.01 % of MV + 0.01 % of MR	0.015 %/kHz	< 1° @ 100 kHz	> 300 kHz	7 V _{rms} @ 200 mA _{rms}	< 0.1 ppm/mW
MCTS/VM0.1/0.02	10 Ω	0.01 % of MV + 0.01 % of MR	0.015 %/kHz	< 1° @ 100 kHz	> 300 kHz	7 V _{rms} @ 100 mA _{rms}	< 0.1 ppm/mW

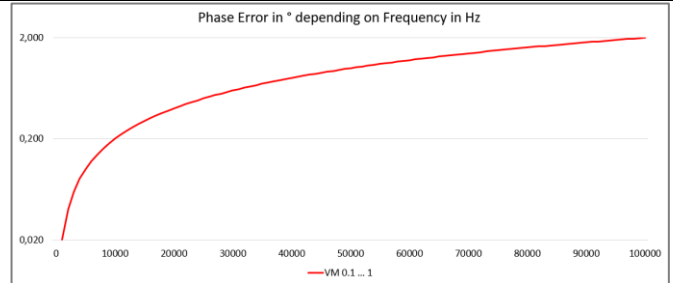
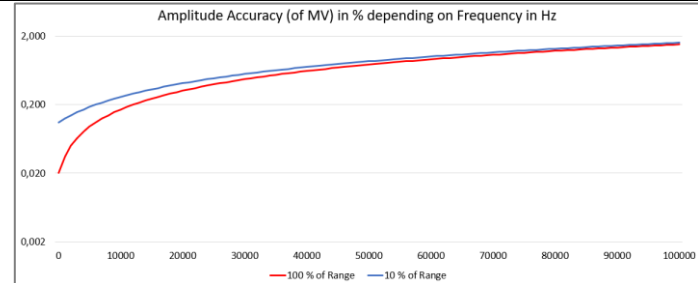

Transducer	Active VM	Scaling	Output Voltage
CT 100	MCTS/VM0.2/0.02	70 mV/A	7 V _{rms} @ 100 A _{rms}
CT 200	MCTS/VM0.2/0.02	35 mV/A	7 V _{rms} @ 200 A _{rms}
CT 400	MCTS/VM0.26/0.02	17.5 mV/A	7 V _{rms} @ 400 A _{rms}
CT 500	MCTS/VM0.66/0.02	14 mV/A	7 V _{rms} @ 500 A _{rms}
CT 1000	MCTS/VM0.66/0.02	7 mV/A	7 V _{rms} @ 1000 A _{rms}
CT 2000	MCTS/VM1/0.02	3.5 mV/A	7 V _{rms} @ 2000 A _{rms}

Connection Cables



Connection cables from the MCTS rack to the transducers are available in various cable lengths. Special cable lengths can be manufactured according demand. Be aware that the cable resistance is part of the maximum measuring resistance mentioned in the transducer data sheets. The cables are available with two different wire cross sections, 0.34 mm² and 0.75 mm².

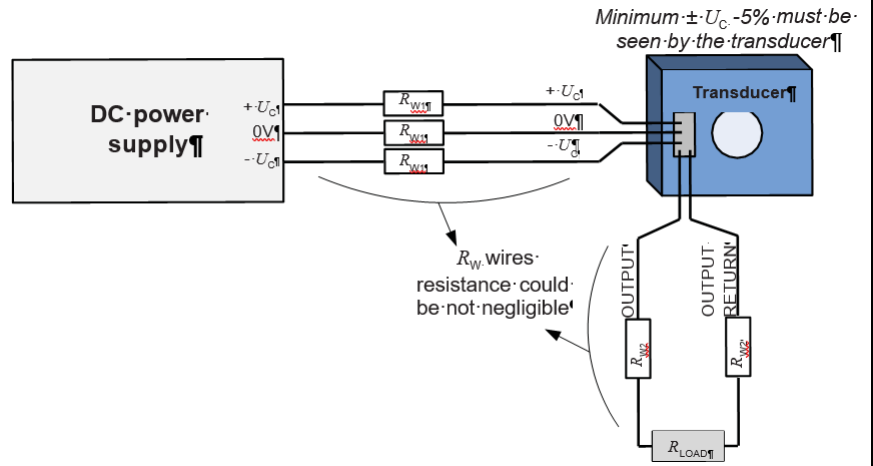

Standard Connection Cables

Order Number	Cable Length	Wire Cross Section	Single Wire Resistance	Loop Resistance (4 x R _{WIRE})	Mass
MCTS/TPS/1	1 m	0.34 mm ²	0.05 Ω	0.21 Ω	0.15 kg
MCTS/TPS/1.5	1.5 m	0.34 mm ²	0.08 Ω	0.31 Ω	0.21 kg
MCTS/TPS/2.5	2.5 m	0.34 mm ²	0.13 Ω	0.52 Ω	0.28 kg
MCTS/TPS/3	3 m	0.34 mm ²	0.16 Ω	0.63 Ω	0.32 kg
MCTS/TPS/5	5 m	0.34 mm ²	0.26 Ω	1.05 Ω	0.47 kg
MCTS/TPS/10	10 m	0.34 mm ²	0.52 Ω	2.09 Ω	0.84 kg
MCTS/TPS/15	15 m	0.34 mm ²	0.79 Ω	3.14 Ω	1.21 kg
MCTS/TPS/20	20 m	0.34 mm ²	1.05 Ω	4.19 Ω	1.58 kg
MCTS/TPS/2.5/0.75	2.5 m	0.75 mm ²	0.06 Ω	0.24 Ω	0.37 kg
MCTS/TPS/5/0.75	5 m	0.75 mm ²	0.12 Ω	0.47 Ω	0.65 kg
MCTS/TPS/10/0.75	10 m	0.75 mm ²	0.24 Ω	0.95 Ω	1.15 kg
MCTS/TPS/15/0.75	15 m	0.75 mm ²	0.36 Ω	1.42 Ω	1.70 kg
MCTS/TPS/20/0.75	20 m	0.75 mm ²	0.47 Ω	1.90 Ω	2.30 kg
MCTS/TPS/25/0.75	20 m	0.75 mm ²	0.59 Ω	2.37 Ω	2.80 kg
MCTS/TPS/30/0.75	30 m	0.75 mm ²	0.71 Ω	2.85 Ω	3.30 kg

Total Measuring Resistance at Full Scale. Other Resistance Values in Graphs on page 3.

Transducer	Measuring Resistance
CT 100	25 Ω
CT 200	20 Ω
CT 400	10 Ω
CT 500	5 Ω
CT 1000	4 Ω
CT 2000	3.5 Ω

Maximum Burden Resistor depending on Transducer and Connection Cable

The remaining burden resistance can be calculated by the subtraction of the connection cable loop resistance from the transducer total measuring resistance.

Example CT 1000 with 15 meters cable 0.34 mm² and 0.75 mm²:



CT 1000 total measuring resistance: 4 Ω at 1000 A_{rms}

MCTS/TPS/15 loop resistance: 3.14 Ω → Maximum allowed burden resistor = 4 Ω - 3.14 Ω = 0.86 Ω

MCTS/TPS/15/0.75 loop resistance: 1.42 Ω → Maximum allowed burden resistor = 4 Ω - 1.42 Ω = 2.58 Ω

Dimensions

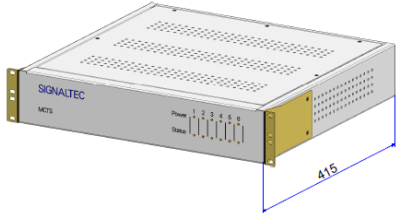
Rack

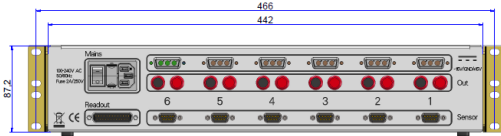
Cabinet Width:	442 mm (19" rack type)
Cabinet Height:	87,2 mm (2 HU)
Cabinet Depth:	415 mm
Mass Basic Unit:	6.8 kg
Mass Internal power supply:	0.5 kg
Mass 19" mounting brackets:	0.5 kg

Transducers CT 100, CT 200, CT 400





Transducers CT 500, CT 1000

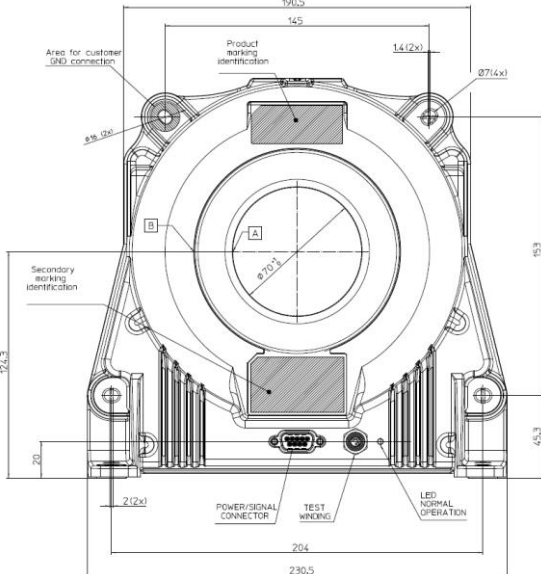
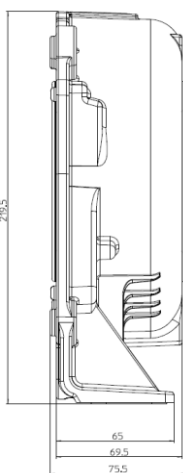
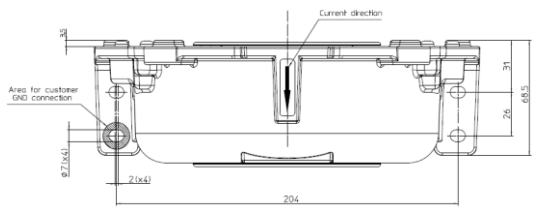

Transducer CT 2000





Passive plug-on burden resistors



Width:	51 mm
Height:	51 mm
Depth:	62 mm (Connectors included)
Mass:	85 g

Active plug-on voltage output modules



Width:	51 mm
Height:	51 mm
Depth:	62 mm (Connectors included)
Mass:	105 g

Accessories

	<p>MCTS/CB</p> <p>Carrying bag for rack, transducers, cables and burden modules</p>
	<p>TSC</p> <p>Transducer soft case for use with carrying bag</p> <p>TSC1 for CT 100, CT 200, CT 400 TSC2 for CT 500, CT 1000 TSC4 for CT 2000</p>
	<p>MCTS/ROC</p> <p>18-pole D-SUB-cable for status-readout-interface, length 3 m</p>
	<p>BNC4A</p> <p>BNC to 4 mm banana-plug adapter</p>
	<p>BPL0.5</p> <p>4 mm banana-plug test lead set, length 0.5 m</p>
	<p>BPL01</p> <p>4 mm banana-plug test lead set, length 1 m</p>
	<p>BNCL1</p> <p>BNC to BNC test lead, length 1 m</p>
	<p>BNC4L1</p> <p>BNC to 4 mm banana-plug test lead, length 1 m</p>

Order Numbers

MCTS Racks MCTS2/1CH MCTS2/2CH MCTS2/3CH MCTS2/4CH MCTS2/5CH MCTS2/6CH MCTS2/BU MCTS/PS	Basic unit with one internal power supply including 19" mounting brackets, power cord and manual Basic unit with two internal power supplies including 19" mounting brackets, power cord and manual Basic unit with three internal power supplies including 19" mounting brackets, power cord and manual Basic unit with four internal power supplies including 19" mounting brackets, power cord and manual Basic unit with five internal power supplies including 19" mounting brackets, power cord and manual Basic unit with six internal power supplies including 19" mounting brackets, power cord and manual Basic unit without internal power supply including 19" mounting brackets, power cord and manual Internal power Supply
Current Transducers CT 100 CT 200 CT 400 CT 500 CT 1000 CT 2000	AC/DC current transducer 100 A _{rms} AC/DC current transducer 200 A _{rms} AC/DC current transducer 400 A _{rms} AC/DC current transducer 500 A _{rms} AC/DC current transducer 1000 A _{rms} AC/DC current transducer 2000 A _{rms}
Connection Cables MCTS/TPS/1 MCTS/TPS/1.5 MCTS/TPS/2.5 MCTS/TPS/3 MCTS/TPS/5 MCTS/TPS/10 MCTS/TPS/15 MCTS/TPS/20 MCTS/TPS/2.5/0.75 MCTS/TPS/5/0.75 MCTS/TPS/10/0.75 MCTS/TPS/15/0.75 MCTS/TPS/20/0.75 MCTS/TPS/25/0.75 MCTS/TPS/30/0.75	1.5 meters connection cable, 0.34 mm ² 1.5 meters connection cable, 0.34 mm ² 2.5 meters connection cable, 0.34 mm ² 3 meters connection cable, 0.34 mm ² 5 meters connection cable, 0.34 mm ² 10 meters connection cable, 0.34 mm ² 15 meters connection cable, 0.34 mm ² 20 meters connection cable, 0.34 mm ² 2.5 meters connection cable, 0.75 mm ² 5 meters connection cable, 0.75 mm ² 10 meters connection cable, 0.75 mm ² 15 meters connection cable, 0.75 mm ² 20 meters connection cable, 0.75 mm ² 25 meters connection cable, 0.75 mm ² 30 meters connection cable, 0.75 mm ²
Passive Burden Resistors MCTS/BR1/0.025 MCTS/BR1.5/0.025 MCTS/BR2.5/0.025 MCTS/BR3.75/0.025 MCTS/BR5/0.025 MCTS/BR10/0.015 MCTS/BR25/0.015 MCTS/BR50/0.015	1 Ω plug-on burden resistor for MCTS/TPS 1.5 Ω plug-on burden resistor for MCTS/TPS 2.5 Ω plug-on burden resistor for MCTS/TPS 3.75 Ω plug-on burden resistor for MCTS/TPS 5 Ω plug-on burden resistor for MCTS/TPS 10 Ω plug-on burden resistor for MCTS/TPS 25 Ω plug-on burden resistor for MCTS/TPS 50 Ω plug-on burden resistor for MCTS/TPS
Active Voltage Output Modules MCTS/VM1/0.02 MCTS/VM0.66/0.02 MCTS/VM0.4/0.02 MCTS/VM0.26/0.02 MCTS/VM0.2/0.02 MCTS/VM0.1/0.02	Plug-on output current amplifier 1A/7V Plug-on output current amplifier 667mA/7V Plug-on output current amplifier 400mA/7V Plug-on output current amplifier 267mA/7V Plug-on output current amplifier 200mA/7V Plug-on output current amplifier 100mA/7V
Accessories MCTS/CB TSC1 TSC2 TSC4 MCTS/ROC BPL0.5 BPL1 BNCL1 BNC4L1 BNC4A	Carrying bag for MCTS rack, transducers and cables Transducer soft case for CT 100, CT 200, CT 400 Transducer soft case for CT 500, CT 1000 Transducer soft case for CT 2000 Status readout interface cable, length 3 m 4mm banana-plug test lead set for MCTS current output terminals, red and black, length 0.5 m 4mm banana-plug test lead set for MCTS current output terminals, red and black, length 1 m BNC to BNC test lead, length 1 m BNC to 4 mm banana-plug test lead, length 1 m BNC to 4 mm banana-plug adapter