

# TPS II

## Single Channel Current Transducer System

### Specifications



# Electronics-Rack

Standard transducer status readout interface  
 Supply voltage for active burden modules  
 19"-rack mountable device



General Data	
Operation Temperature:	-10 ... 60 °C
Operation Humidity:	20 ... 90 % RH, noncondensing
Warranty period:	36 Months

Electrical Data	
Supply voltage:	100-240 VAC, 50/60 Hz, fused with 2 A slow blow
Output voltages:	+ 15 V <sub>DC</sub> , 3.4 A <sub>max</sub> / -15 V <sub>DC</sub> , 2.0 A <sub>max</sub>
Max. Power Consumption:	The maximum power consumption depends on the current consumption of the connected transducer. The maximum power consumption of a TPS with transducer CT 2000 at 2000 A <sub>rms</sub> primary current is around 30 W.

**Power and Transducer Status Functions**

Power and transducer status are visible at the TPS front panel and can be read out via the Status-Readout Interface

Power LED **green**: Power Supply installed  
 Power LED off: Power Supply not installed

Status LED **green**: Transducer ok  
 Status LED **red**: Transducer overload or open output

This interface gives out the transducer status by means of potential free relay contacts.

Switching voltage: 200 V  
 Switching current: 2 A

A status readout cable is available as an option.

Status-Readout-Interface

**DC-voltage output for active burden modules**

Normally the current transducers for higher primary current levels are not able to drive much more than 1 V at the output. If this is enough, our passive plug-on burden resistors are the right solution to get a mV/A-signal out of the sensor. If the connected measurement instrument demands a higher voltage signal level, our active plug-on voltage modules are the right solution. These deliver 7 V<sub>rms</sub> (± 9.9 V<sub>pk</sub>) at transducer nominal primary current.

# Current Transducers

Type	CT 100	CT 200	CT 400	CT 500	CT 1000	CT 2000
Current Range	100 A	200 A	400 A	500 A	1000 A	2000 A
DC / AC <sub>rms</sub> (Crestfactor 2)						
100 ms Overload	20 kA <sub>pk</sub>	20 kA <sub>pk</sub>	20 kA <sub>pk</sub>	3 kA <sub>pk</sub>	5 kA <sub>pk</sub>	10 kA <sub>pk</sub>
Ratio	500 : 1	1000 : 1	1500 : 1	750 : 1	1500 : 1	2000 : 1
Output Range	0 ... 200 mA <sub>rms</sub>	0 ... 200 mA <sub>rms</sub>	0 ... 266.667 mA <sub>rms</sub>	0 ... 666.667 mA <sub>rms</sub>	0 ... 666.667 mA <sub>rms</sub>	0 ... 1 A <sub>rms</sub>
Max. Measuring Resistance <sup>1</sup>	25 Ω	20 Ω	10 Ω	5 Ω	4 Ω	3.5 Ω
Bandwidth (-3 dB)	DC ... 2 MHz	DC ... 1.1 MHz	DC ... 800 kHz	DC ... 520 kHz	DC ... 440 kHz	DC ... 140 kHz
Step Response (0 ... 90 %)	0.2 μs	0.2 μs	1 μs	1 μs	1 μs	1 μs
DC Accuracy (of MR) <sup>2</sup>	0.002 %	0.001 %	0.0008 %	0.00115 %	0.0012 %	0.0012 %
AC Accuracy (of MV) <sup>3</sup>						
> 0 ... ≤ 100 Hz	0.015 %	0.015 %	0.015 %	0.015 %	0.015 %	0.015 %
> 100 ... ≤ 1000 Hz	0.025 %	0.02 %	0.02 %	0.02 %	0.02 %	0.05 %
> 1000 ... ≤ 10000 Hz	0.2 %	0.15 %	0.15 %	0.1 %	0.15 %	0.25 %
> 10000 ... ≤ 50000 Hz <sup>4</sup>	0.5 %	0.5 %	0.5 %	0.2 %	1.5 %	1 % <sup>4</sup>
> 50000 ... ≤ 100000 Hz	1 %	1 %	1 %	0.5 %	4 %	
Angular Accuracy						
> 0 ... ≤ 100 Hz	0.01 °	0.01 °	0.01 °	0.01 °	0.01 °	0.01 °
> 100 ... ≤ 1000 Hz	0.05 °	0.02 °	0.01 °	0.01 °	0.01 °	0.05 °
> 1000 ... ≤ 10000 Hz	0.1 °	0.05 °	0.1 °	0.05 °	0.1 °	0.1 °
> 10000 ... ≤ 50000 Hz <sup>4</sup>	0.25 °	0.25 °	0.5 °	0.5 °	1 °	1 ° <sup>4</sup>
> 50000 ... ≤ 100000 Hz	0.5 °	0.5 °	1 °	1 °	2 °	
Temp.-Coefficient (of MR)	0.2 ppm/K	0.2 ppm/K	0.1 ppm/K	1 ppm/K	0.3 ppm/K	0.1 ppm/K
Temperature Range	-40 ... 85 °C	-40 ... 85 °C	-40 ... 85 °C	-40 ... 85 °C	-40 ... 85 °C	-40 ... 85 °C
Test Voltage 50 Hz	4.95 kV	4.95 kV	4.95 kV	4.2 kV	4.2 kV	6 kV
Inner Diameter	28 mm	28 mm	28 mm	38 mm	38 mm	70 mm
Mass	0.275 kg	0.295 kg	0.305 kg	1.3 kg	1.3 kg	4.2 kg

<sup>1</sup> At full scale and 25 °C. For other current values and temperatures see graphs below. Max measuring resistance = cable loop resistance + burden resistance (see page 5).

<sup>2</sup> Error of measuring range. At 25 °C.

<sup>3</sup> Error of measured value. For range 3 % ... 100 %. Test current 0 ... 100 Arms, DC ... 100 kHz. At 25 °C.

<sup>4</sup> CT 2000: 10000 ... ≤ 20000 Hz. The precision frequency range of CT 2000 is limited to 20 kHz.

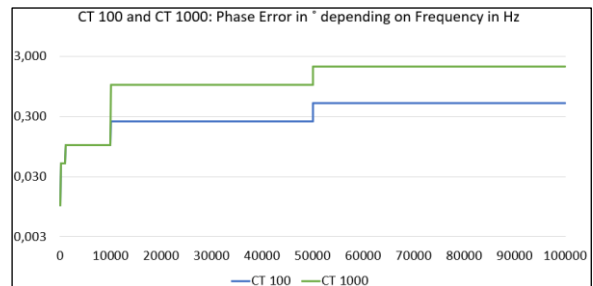
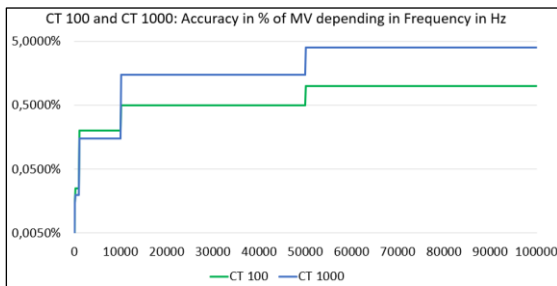

## Maximum measuring resistance (cable- + burden-resistance) depending on primary rms current and surrounding temperature

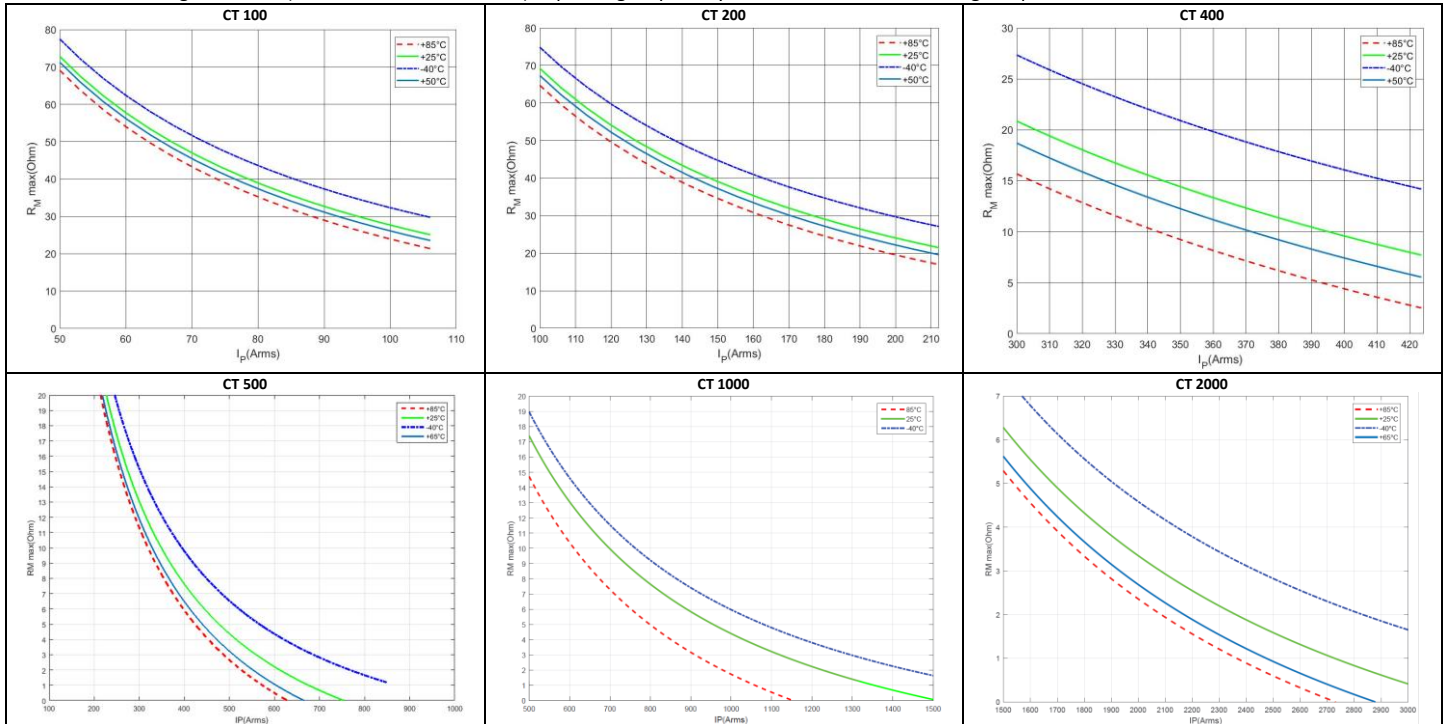

# Burden Modules



The transducer system delivers the transducer output current at the 4 mm output terminals on the back panel of the rack. For those instruments that don't have current input terminals, optional high precision passive and active plug-on burden modules with very low phase angle error are available. The active voltage output modules are supplied by the TPS rack with a 3-pole D-SUB connector.

## Passive plug-on burden resistors



Passive plug-on burden resistors are available from 1 Ω to 50 Ω. The burden resistor is limited by the transducer and the length of the connection cable. For higher output voltages active plug-on burden amplifiers are available.

Order Number	Resistance Value	Accuracy	Frequency Influence	Phase Error	Bandwidth	Max. Output Voltage	Load Influence
MCTS/BR1/0.025	1 Ω	0.025 % of MV	0.0005 %/kHz	< 1° @ 100 kHz	> 1 MHz	1.00 V <sub>rms</sub> @ 1000 mA <sub>rms</sub>	< 0.1 ppm/mW
MCTS/BR1.5/0.025	1.5 Ω	0.025 % of MV	0.0005 %/kHz	< 1° @ 100 kHz	> 1 MHz	1.00 V <sub>rms</sub> @ 667 mA <sub>rms</sub>	< 0.1 ppm/mW
MCTS/BR2.5/0.025	2.5 Ω	0.025 % of MV	0.0005 %/kHz	< 1° @ 100 kHz	> 1 MHz	1.58 V <sub>rms</sub> @ 632 mA <sub>rms</sub>	< 0.1 ppm/mW
MCTS/BR3.75/0.025	3.75 Ω	0.025 % of MV	0.0005 %/kHz	< 1° @ 100 kHz	> 1 MHz	1.94 V <sub>rms</sub> @ 516 mA <sub>rms</sub>	< 0.1 ppm/mW
MCTS/BR5/0.025	5 Ω	0.025 % of MV	0.0005 %/kHz	< 1° @ 100 kHz	> 1 MHz	2.24 V <sub>rms</sub> @ 447 mA <sub>rms</sub>	< 0.1 ppm/mW
MCTS/BR10/0.015	10 Ω	0.015 % of MV	0.0005 %/kHz	< 1° @ 100 kHz	> 1 MHz	3.16 V <sub>rms</sub> @ 316 mA <sub>rms</sub>	< 0.1 ppm/mW
MCTS/BR25/0.015	25 Ω	0.015 % of MV	0.0005 %/kHz	< 1° @ 100 kHz	> 1 MHz	5.00 V <sub>rms</sub> @ 200 mA <sub>rms</sub>	< 0.1 ppm/mW
MCTS/BR50/0.015	50 Ω	0.015 % of MV	0.0005 %/kHz	< 1° @ 100 kHz	> 1 MHz	7.07 V <sub>rms</sub> @ 141 mA <sub>rms</sub>	< 0.1 ppm/mW

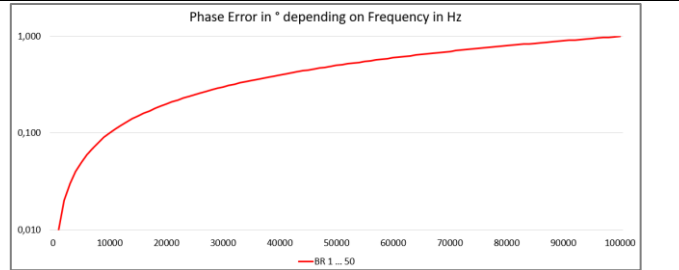
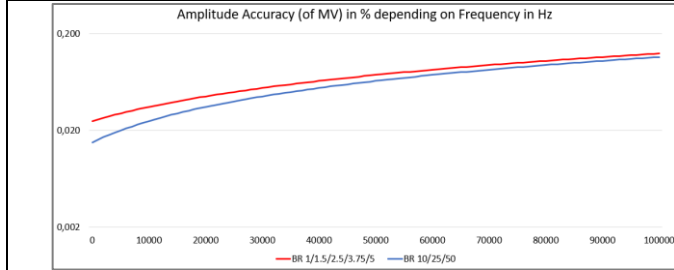

Transducer	Passive BR	Scaling	Output Voltage
CT 100	MCTS/BR10/0.015	20 mV/A	2 V <sub>rms</sub> @ 100 A <sub>rms</sub>
CT 200	MCTS/BR10/0.015	10 mV/A	2 V <sub>rms</sub> @ 200 A <sub>rms</sub>
CT 400	MCTS/BR3.75/0.025	2.5 mV/A	1 V <sub>rms</sub> @ 400 A <sub>rms</sub>
CT 500	MCTS/BR1.5/0.025	2 mV/A	1 V <sub>rms</sub> @ 500 A <sub>rms</sub>
CT 1000	MCTS/BR1.5/0.025	1 mV/A	1 V <sub>rms</sub> @ 1000 A <sub>rms</sub>
CT 2000	MCTS/BR1/0.025	0.5 mV/A	1 V <sub>rms</sub> @ 2000 A <sub>rms</sub>

## Active plug-on voltage output modules



The output voltage level the transducer can drive is limited. The active plug-on burden modules combine a very precise burden resistor with a highly accurate voltage amplifier. The plug-on burden voltage modules deliver 7 V<sub>rms</sub> (± 9.9 V<sub>pk</sub>) at transducer nominal value.

Order Number	Input Resistance	Accuracy	Frequency Influence	Phase Error	Bandwidth	Max. Output Voltage	Load Influence
MCTS/VM1/0.02	1 Ω	0.01 % of MV + 0.01 % of MR	0.015 %/kHz	< 1° @ 100 kHz	> 300 kHz	7 V <sub>rms</sub> @ 1000 mA <sub>rms</sub>	< 0.1 ppm/mW
MCTS/VM0.66/0.02	1.5 Ω	0.01 % of MV + 0.01 % of MR	0.015 %/kHz	< 1° @ 100 kHz	> 300 kHz	7 V <sub>rms</sub> @ 667 mA <sub>rms</sub>	< 0.1 ppm/mW
MCTS/VM0.4/0.02	2.5 Ω	0.01 % of MV + 0.01 % of MR	0.015 %/kHz	< 1° @ 100 kHz	> 300 kHz	7 V <sub>rms</sub> @ 400 mA <sub>rms</sub>	< 0.1 ppm/mW
MCTS/VM0.26/0.02	3.75 Ω	0.01 % of MV + 0.01 % of MR	0.015 %/kHz	< 1° @ 100 kHz	> 300 kHz	7 V <sub>rms</sub> @ 267 mA <sub>rms</sub>	< 0.1 ppm/mW
MCTS/VM0.2/0.02	5 Ω	0.01 % of MV + 0.01 % of MR	0.015 %/kHz	< 1° @ 100 kHz	> 300 kHz	7 V <sub>rms</sub> @ 200 mA <sub>rms</sub>	< 0.1 ppm/mW
MCTS/VM0.1/0.02	10 Ω	0.01 % of MV + 0.01 % of MR	0.015 %/kHz	< 1° @ 100 kHz	> 300 kHz	7 V <sub>rms</sub> @ 100 mA <sub>rms</sub>	< 0.1 ppm/mW

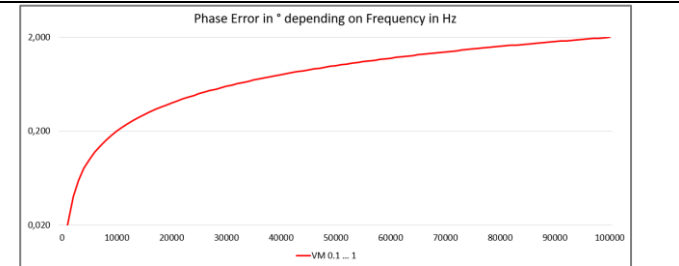
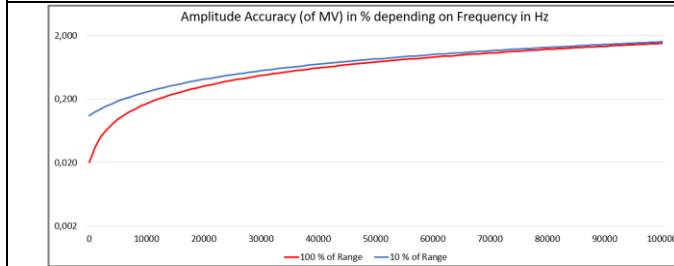

Transducer	Active VM	Scaling	Output Voltage
CT 100	MCTS/VM0.2/0.02	70 mV/A	7 V <sub>rms</sub> @ 100 A <sub>rms</sub>
CT 200	MCTS/VM0.2/0.02	35 mV/A	7 V <sub>rms</sub> @ 200 A <sub>rms</sub>
CT 400	MCTS/VM0.26/0.02	17.5 mV/A	7 V <sub>rms</sub> @ 400 A <sub>rms</sub>
CT 500	MCTS/VM0.66/0.02	14 mV/A	7 V <sub>rms</sub> @ 500 A <sub>rms</sub>
CT 1000	MCTS/VM0.66/0.02	7 mV/A	7 V <sub>rms</sub> @ 1000 A <sub>rms</sub>
CT 2000	MCTS/VM1/0.02	3.5 mV/A	7 V <sub>rms</sub> @ 2000 A <sub>rms</sub>

## Connection Cables



Connection cables from the TPS rack to the transducer are available in various cable lengths. Special cable lengths can be manufactured according demand. Be aware that the cable resistance is part of the maximum measuring resistance. The cables are available with two different wire cross sections, 0.34 mm<sup>2</sup> and 0.75 mm<sup>2</sup>.

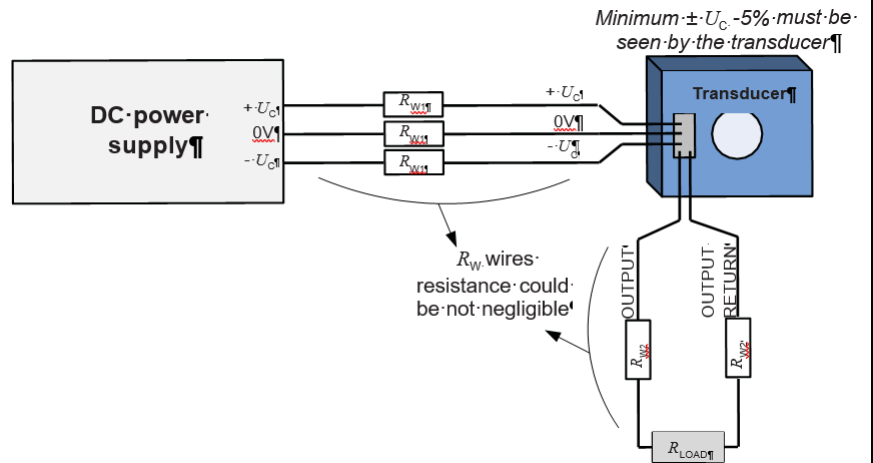

### Standard Connection Cables

Order Number	Cable Length	Wire Cross Section	Single Wire Resistance	Loop Resistance (4 x R <sub>WIRE</sub> )	Mass
MCTS/TPS/1	1 m	0.34 mm <sup>2</sup>	0.05 Ω	0.21 Ω	0.15 kg
MCTS/TPS/1.5	1.5 m	0.34 mm <sup>2</sup>	0.08 Ω	0.31 Ω	0.21 kg
MCTS/TPS/2.5	2.5 m	0.34 mm <sup>2</sup>	0.13 Ω	0.52 Ω	0.28 kg
MCTS/TPS/3	3 m	0.34 mm <sup>2</sup>	0.16 Ω	0.63 Ω	0.32 kg
MCTS/TPS/5	5 m	0.34 mm <sup>2</sup>	0.26 Ω	1.05 Ω	0.47 kg
MCTS/TPS/10	10 m	0.34 mm <sup>2</sup>	0.52 Ω	2.09 Ω	0.84 kg
MCTS/TPS/15	15 m	0.34 mm <sup>2</sup>	0.79 Ω	3.14 Ω	1.21 kg
MCTS/TPS/20	20 m	0.34 mm <sup>2</sup>	1.05 Ω	4.19 Ω	1.58 kg
MCTS/TPS/2.5/0.75	2.5 m	0.75 mm <sup>2</sup>	0.06 Ω	0.24 Ω	0.37 kg
MCTS/TPS/5/0.75	5 m	0.75 mm <sup>2</sup>	0.12 Ω	0.47 Ω	0.65 kg
MCTS/TPS/10/0.75	10 m	0.75 mm <sup>2</sup>	0.24 Ω	0.95 Ω	1.15 kg
MCTS/TPS/15/0.75	15 m	0.75 mm <sup>2</sup>	0.36 Ω	1.42 Ω	1.70 kg
MCTS/TPS/20/0.75	20 m	0.75 mm <sup>2</sup>	0.47 Ω	1.90 Ω	2.30 kg
MCTS/TPS/25/0.75	20 m	0.75 mm <sup>2</sup>	0.59 Ω	2.37 Ω	2.80 kg
MCTS/TPS/30/0.75	30 m	0.75 mm <sup>2</sup>	0.71 Ω	2.85 Ω	3.30 kg

### Total Measuring Resistance at Full Scale. Other Resistance Values in Graphs on page 3.

Transducer	Measuring Resistance
CT 100	25 Ω
CT 200	20 Ω
CT 400	10 Ω
CT 500	5 Ω
CT 1000	4 Ω
CT 2000	3.5 Ω

### Maximum Burden Resistor depending on Transducer and Connection Cable

The remaining burden resistance can be calculated by the subtraction of the connection cable loop resistance from the transducer total measuring resistance.

Example CT 1000 with 15 meters cable 0.34 mm<sup>2</sup> and 0.75 mm<sup>2</sup>:

CT 1000 total measuring resistance: 4 Ω at 1000 A<sub>rms</sub>

MCTS/TPS/15 loop resistance: 3.14 Ω → Maximum allowed burden resistor = 4 Ω - 3.14 Ω = 0.86 Ω

MCTS/TPS/15/0.75 loop resistance: 1.42 Ω → Maximum allowed burden resistor = 4 Ω - 1.42 Ω = 2.58 Ω

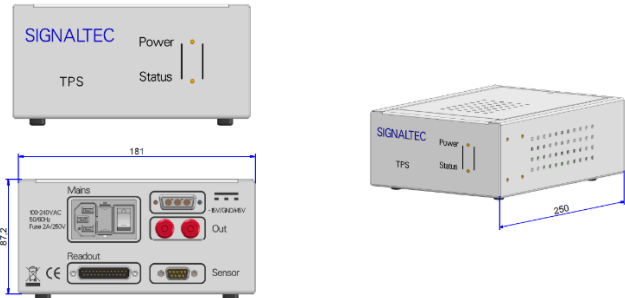

# Dimensions

<p><b>Rack</b></p> 	<p>Cabinet Width: 442 mm (19" rack type)          Cabinet Height: 87.2 mm (2 HU)          Cabinet Depth: 415 mm          Mass Basic Unit: 6.8 kg          Mass Internal power supply: 0.5 kg          Mass 19" mounting brackets: 0.5 kg</p>
--	--

**Transducers CT 100, CT 200, CT 400**





**Transducers CT 500, CT 1000**



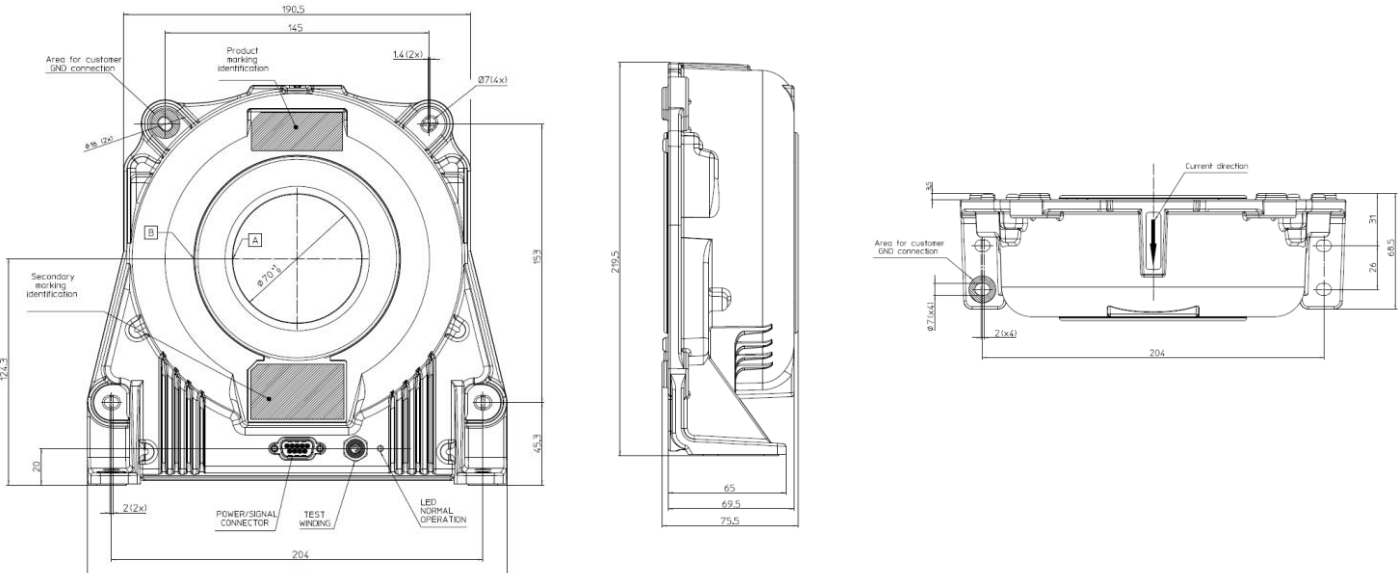

**Transducer CT 2000**

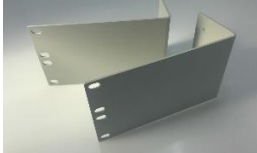

<p><b>Passive plug-on burden resistors</b></p> 	<p>Width: 51 mm          Height: 51 mm          Depth: 62 mm (Connectors included)          Mass: 85 g</p>
<p><b>Active plug-on voltage output modules</b></p> 	<p>Width: 51 mm          Height: 51 mm          Depth: 62 mm (Connectors included)          Mass: 105 g</p>

## Accessories

	<p><b>TPS/RMB</b></p> <p>19" rack mounting brackets for TPS</p>
	<p><b>TPS/CB</b></p> <p>Carrying bag for rack, transducers, cables and burden modules</p>
	<p><b>TSC</b></p> <p>Transducer soft case for use with carrying bag</p> <p><b>TSC1</b> for CT 100, CT 200, CT 400  <b>TSC2</b> for CT 500, CT 1000  <b>TSC4</b> for CT 2000</p>
	<p><b>MCTS/ROC</b></p> <p>18-pole D-SUB-cable for status-readout-interface, length 3 m</p>
	<p><b>BNC4A</b></p> <p>BNC to 4 mm banana-plug adapter</p>
	<p><b>BPL0.5</b></p> <p>4 mm banana-plug test lead set, length 0.5 m</p>
	<p><b>BPL01</b></p> <p>4 mm banana-plug test lead set, length 1 m</p>
	<p><b>BNCL1</b></p> <p>BNC to BNC test lead, length 1 m</p>
	<p><b>BNC4L1</b></p> <p>BNC to 4 mm banana-plug test lead, length 1 m</p>

# Order Numbers

<b>TPS II Rack</b>	
TPS2	Single channel power supply including power cord and manual.
<b>Current Transducers</b>	
CT 100	AC/DC current transducer 100 A <sub>rms</sub>
CT 200	AC/DC current transducer 200 A <sub>rms</sub>
CT 400	AC/DC current transducer 400 A <sub>rms</sub>
CT 500	AC/DC current transducer 500 A <sub>rms</sub>
CT 1000	AC/DC current transducer 1000 A <sub>rms</sub>
CT 2000	AC/DC current transducer 2000 A <sub>rms</sub>
<b>Connection Cables</b>	
MCTS/TPS/1	1.5 meters connection cable, 0.34 mm <sup>2</sup>
MCTS/TPS/1.5	1.5 meters connection cable, 0.34 mm <sup>2</sup>
MCTS/TPS/2.5	2.5 meters connection cable, 0.34 mm <sup>2</sup>
MCTS/TPS/3	3 meters connection cable, 0.34 mm <sup>2</sup>
MCTS/TPS/5	5 meters connection cable, 0.34 mm <sup>2</sup>
MCTS/TPS/10	10 meters connection cable, 0.34 mm <sup>2</sup>
MCTS/TPS/15	15 meters connection cable, 0.34 mm <sup>2</sup>
MCTS/TPS/20	20 meters connection cable, 0.34 mm <sup>2</sup>
MCTS/TPS/2.5/0.75	2.5 meters connection cable, 0.75 mm <sup>2</sup>
MCTS/TPS/5/0.75	5 meters connection cable, 0.75 mm <sup>2</sup>
MCTS/TPS/10/0.75	10 meters connection cable, 0.75 mm <sup>2</sup>
MCTS/TPS/15/0.75	15 meters connection cable, 0.75 mm <sup>2</sup>
MCTS/TPS/20/0.75	20 meters connection cable, 0.75 mm <sup>2</sup>
MCTS/TPS/25/0.75	25 meters connection cable, 0.75 mm <sup>2</sup>
MCTS/TPS/30/0.75	30 meters connection cable, 0.75 mm <sup>2</sup>
<b>Passive Burden Resistors</b>	
MCTS/BR1/0.025	1 Ω plug-on burden resistor for MCTS/TPS
MCTS/BR1.5/0.025	1.5 Ω plug-on burden resistor for MCTS/TPS
MCTS/BR2.5/0.025	2.5 Ω plug-on burden resistor for MCTS/TPS
MCTS/BR3.75/0.025	3.75 Ω plug-on burden resistor for MCTS/TPS
MCTS/BR5/0.025	5 Ω plug-on burden resistor for MCTS/TPS
MCTS/BR10/0.015	10 Ω plug-on burden resistor for MCTS/TPS
MCTS/BR25/0.015	25 Ω plug-on burden resistor for MCTS/TPS
MCTS/BR50/0.015	50 Ω plug-on burden resistor for MCTS/TPS
<b>Active Voltage Output Modules</b>	
MCTS/VM1/0.02	Plug-on output current amplifier 1A/7V
MCTS/VM0.66/0.02	Plug-on output current amplifier 667mA/7V
MCTS/VM0.4/0.02	Plug-on output current amplifier 400mA/7V
MCTS/VM0.26/0.02	Plug-on output current amplifier 267mA/7V
MCTS/VM0.2/0.02	Plug-on output current amplifier 200mA/7V
MCTS/VM0.1/0.02	Plug-on output current amplifier 100mA/7V
<b>Accessories</b>	
TPS/RMB	19" rack mounting brackets
TPS/CB	Carrying bag for TPS rack, transducer and cable
TSC1	Transducer soft case for CT 100, CT 200, CT 400
TSC2	Transducer soft case for CT 500, CT 1000
TSC4	Transducer soft case for CT 2000
TPS/ROC	Status readout interface cable, length 3 m
BPL0.5	4mm banana-plug test lead set for MCTS current output terminals, red and black, length 0.5 m
BPL1	4mm banana-plug test lead set for MCTS current output terminals, red and black, length 1 m
BNCL1	BNC to BNC test lead, length 1 m
BNC4L1	BNC to 4 mm banana-plug test lead, length 1 m
BNC4A	BNC to 4 mm banana-plug adapter